

J/C(5)  
(C-202)

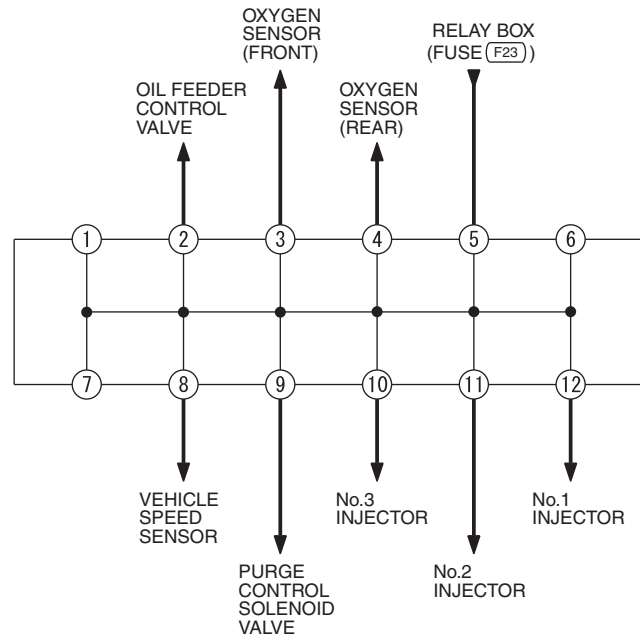

NOTE  
\*1 : LHD  
\*2 : RHD

J/C(7)  
(C-105)  
<LHD>

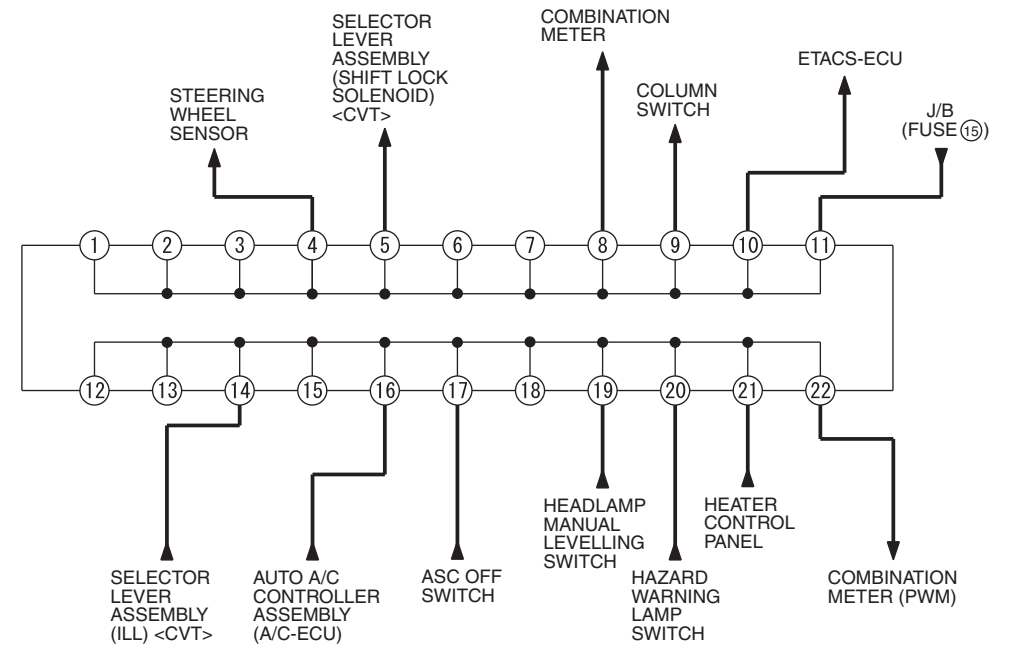

J/C(6)

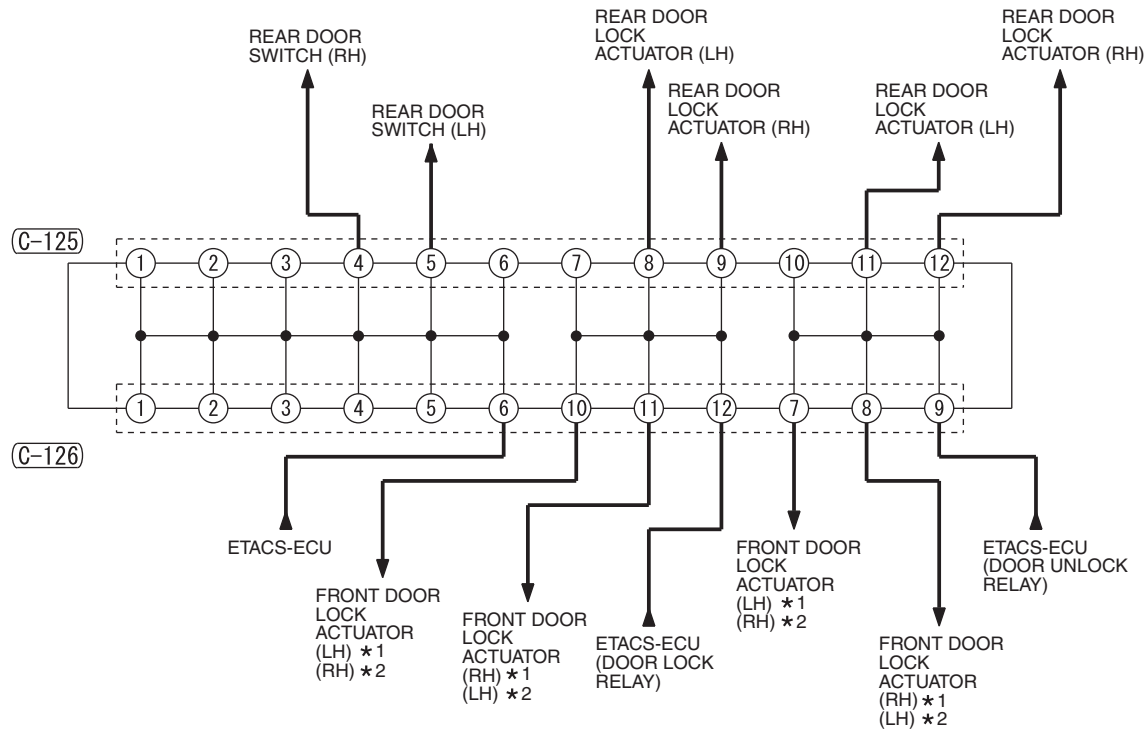

J/C(7)  
(C-105)  
<RHD>

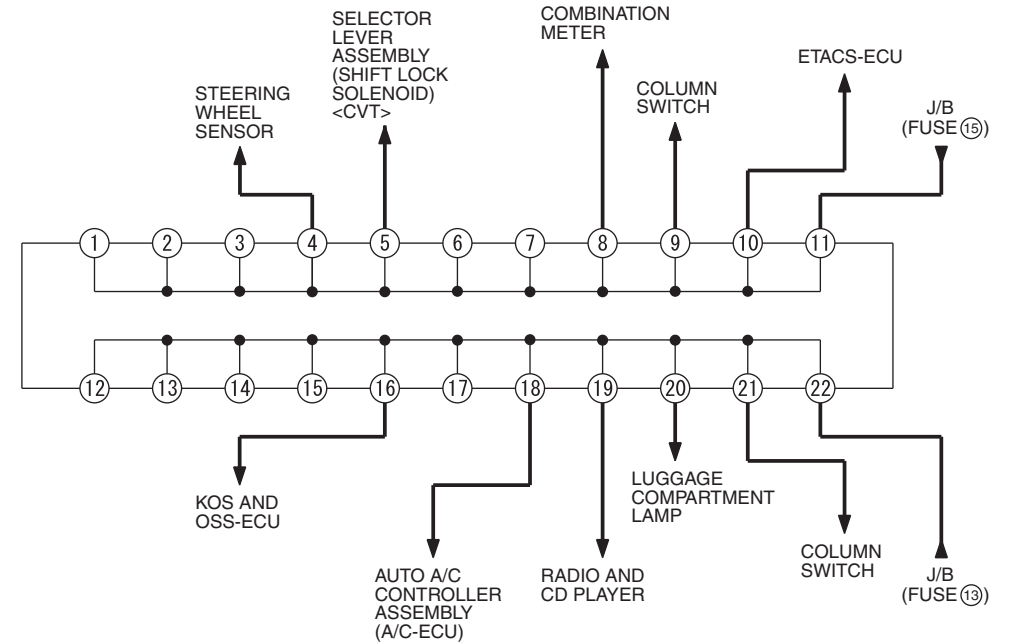

(C-105)

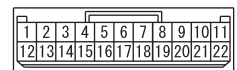

(C-125)

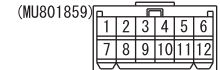

(C-126)

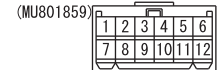

(C-202)

