

# Connectors: C-202, C-205 <RHD>

Junction block (Front view)

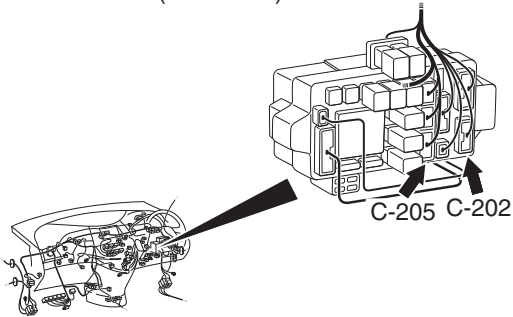

Harness side

C-202

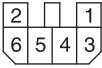

Harness side

C-205

