

# Connectors: C-202, C-203

Junction block (Front view)

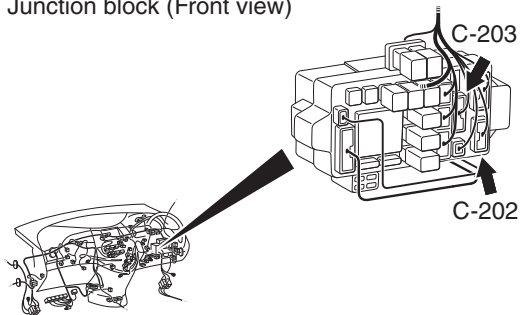

Harness side

C-202

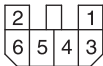

Harness side

C-203

