

FUSIBLE LINK ②

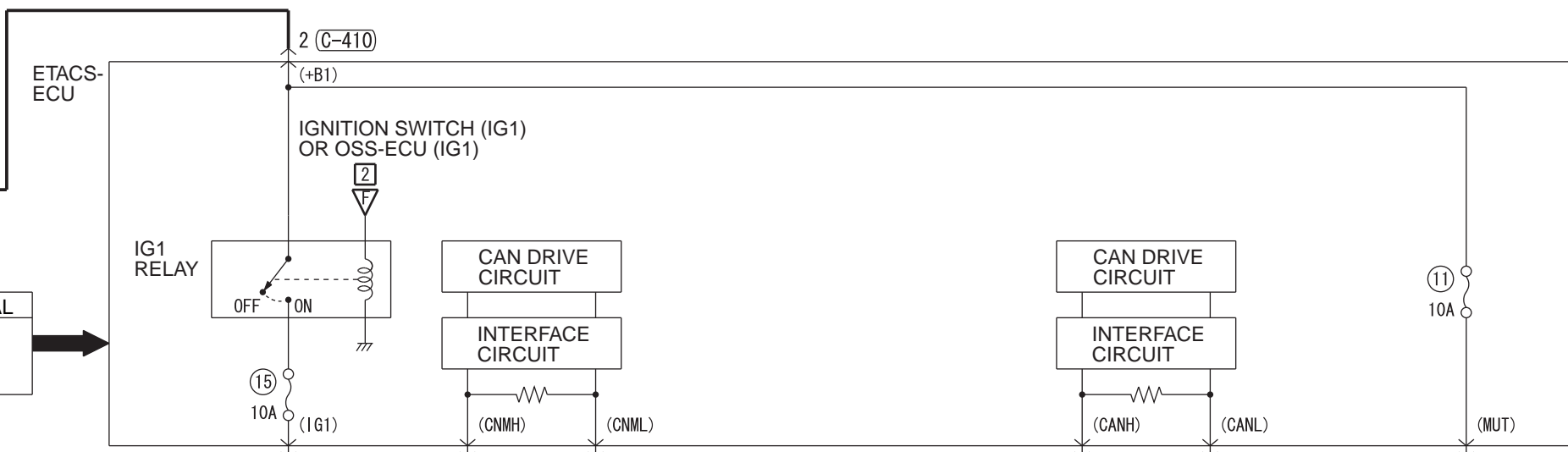

- .ABS-ECU
- .ACS-ECU
- .COLUMN SWITCH
- .CORNER SENSOR/BACK SENSOR-ECU
- .CVT CONTROL RELAY
- .EPS-ECU
- .HAZARD INDICATOR ASSEMBLY
- .HEATED SEAT RELAY
- .HEATER CONTROLLER ASSEMBLY (A/C-ECU)
- .KOS-ECU
- .SELECTOR LEVER ASSEMBLY
- .SONAR SWITCH
- .STEERING WHEEL SENSOR
- .SUNROOF MOTOR ASSEMBLY

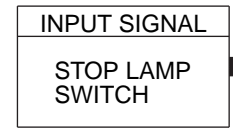
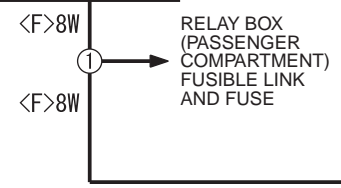
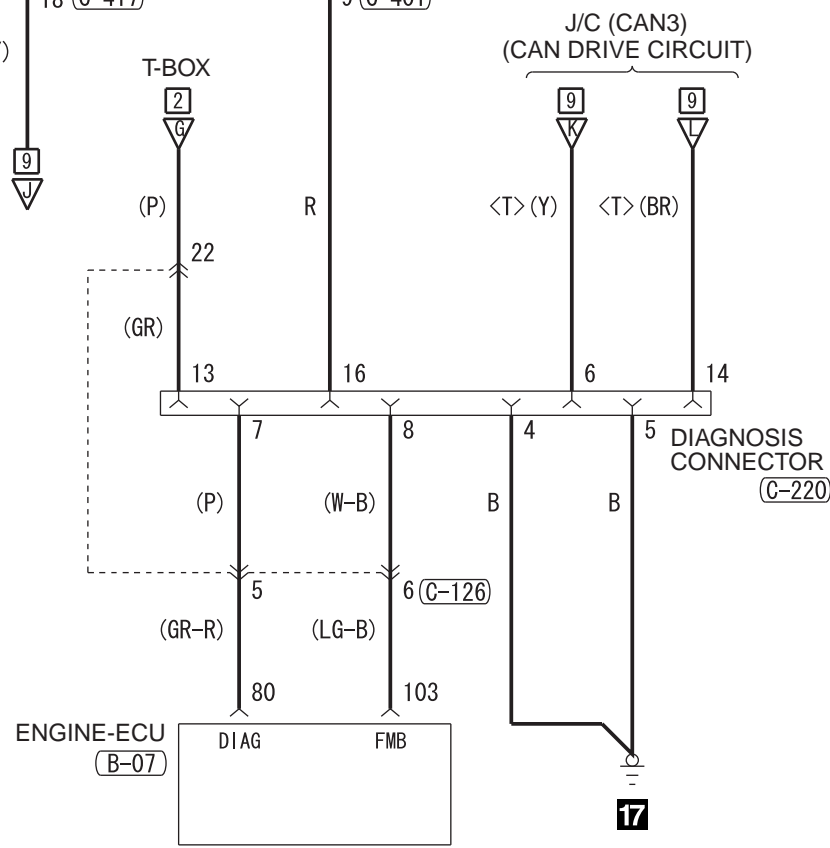
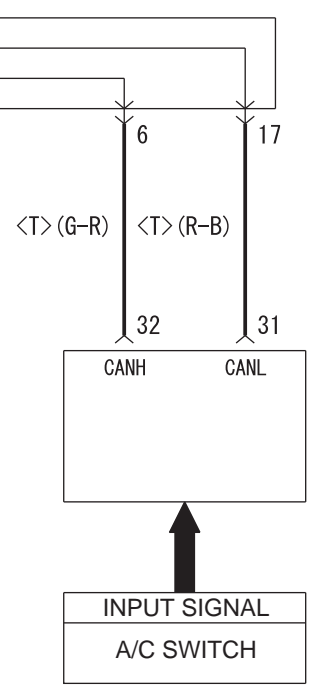
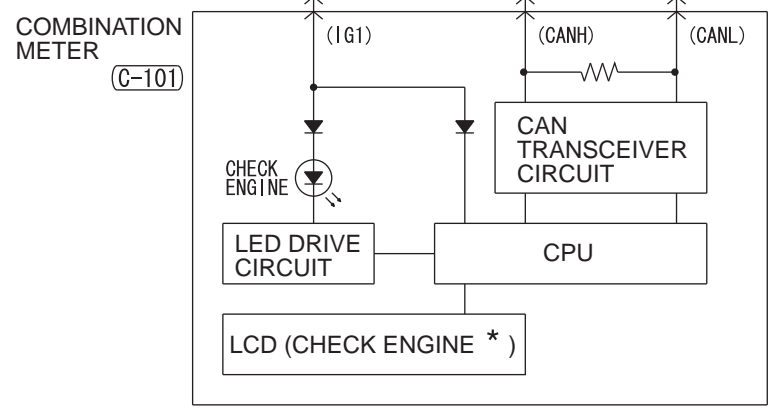

NOTE

* : VEHICLES WITH HIGH CONTRAST METER

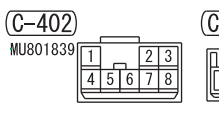
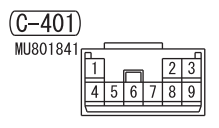
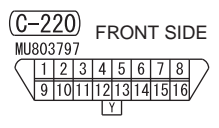
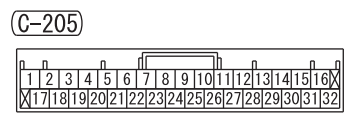
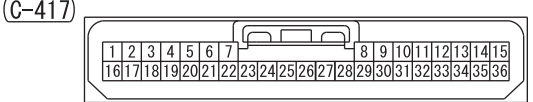
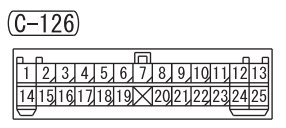
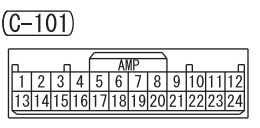
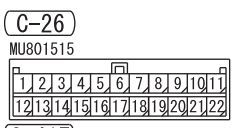
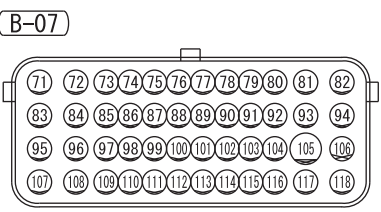

Wire colour code

B : Black LG : Light green G : Green L : Blue W : White Y : Yellow SB : Sky blue

BR : Brown O : Orange GR : Grey R : Red P : Pink V : Violet PU : Purple SI : Silver