

FUSIBLE LINK ②

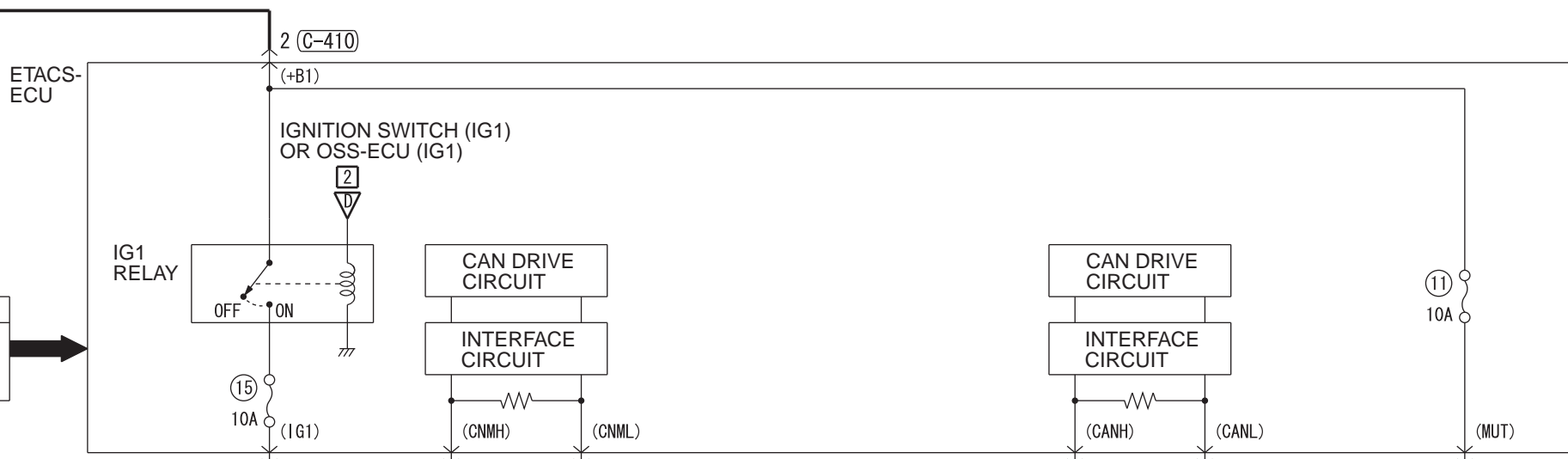

- ABS-ECU
- ACS-ECU
- ACC/FCM-ECU
- A/T CONTROL RELAY
- COLUMN SWITCH
- CORNER SENSOR/BACK SENSOR-ECU
- EPS-ECU
- HAZARD INDICATOR ASSEMBLY
- HEATED SEAT RELAY
- HEATER CONTROLLER ASSEMBLY (A/C-ECU)
- KOS-ECU
- SELECTOR LEVER ASSEMBLY
- SONAR SWITCH
- STEERING WHEEL SENSOR
- SUNROOF MOTOR ASSEMBLY

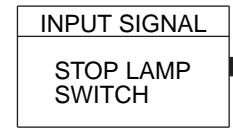
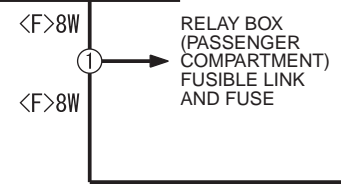
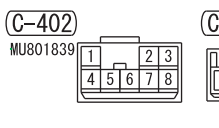
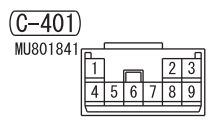
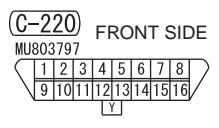
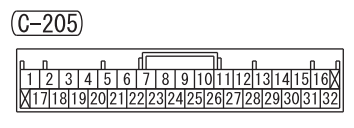
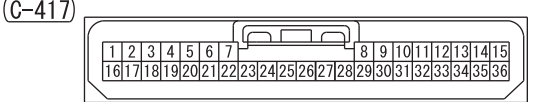
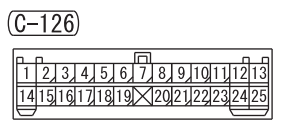
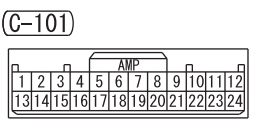
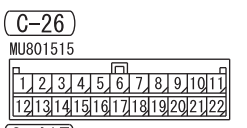
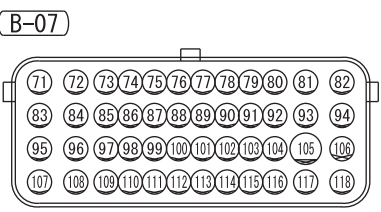
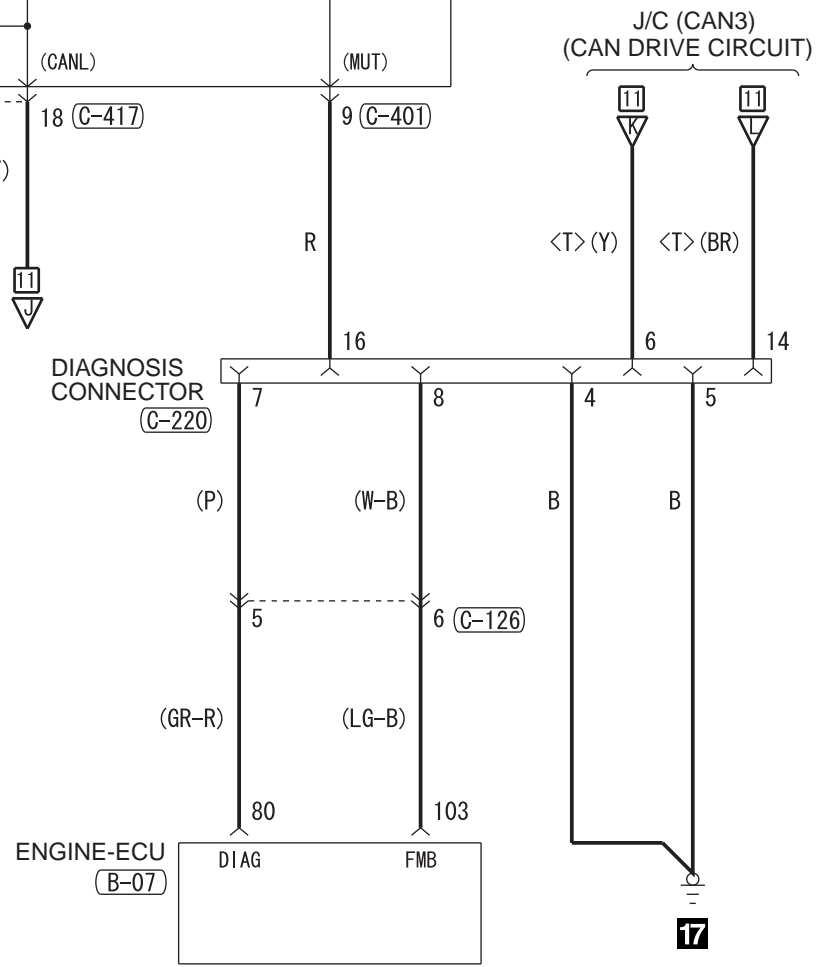
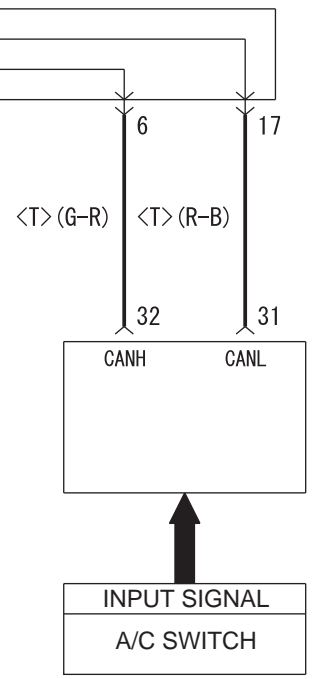
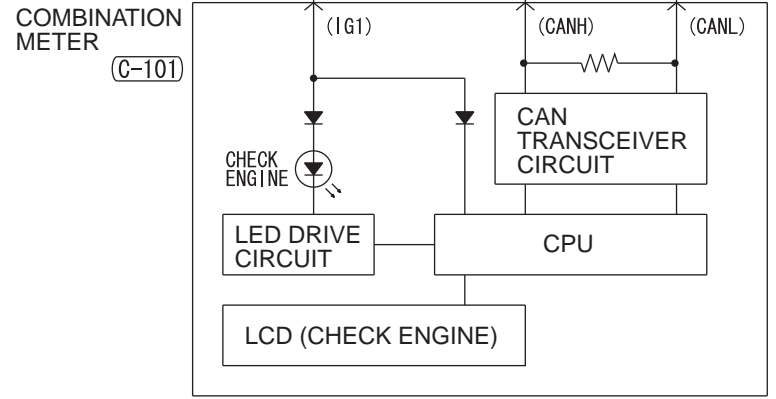

Wire colour code

B : Black LG : Light green G : Green L : Blue W : White Y : Yellow SB : Sky blue

BR : Brown O : Orange GR : Grey R : Red P : Pink V : Violet PU : Purple SI : Silver