

FUSIBLE LINK ⑫

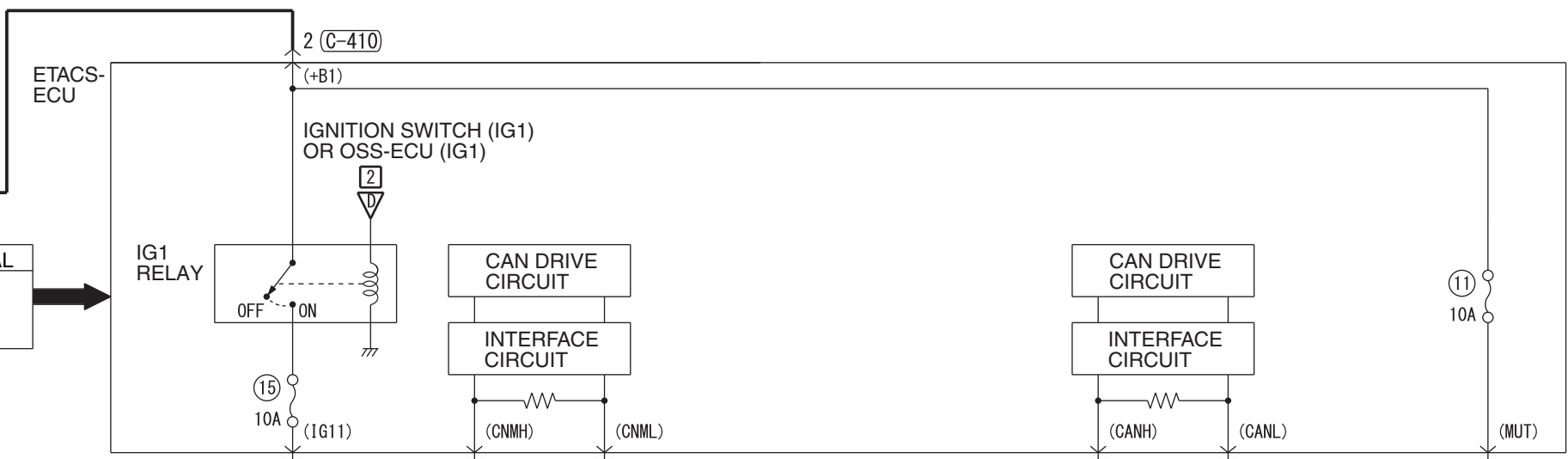

- ACC/FCM-ECU
- ASC-ECU
- A/T CONTROL RELAY
- COLUMN SWITCH
- CORNER SENSOR/BACK SENSOR-ECU
- EPS-ECU
- HAZARD INDICATOR ASSEMBLY
- HEATED SEAT RELAY
- HEATER CONTROLLER ASSEMBLY (A/C-ECU)
- KOS-ECU
- LDW-ECU
- PTC HEATER RELAY
- SELECTOR LEVER ASSEMBLY
- SONAR SWITCH
- STEERING WHEEL SENSOR
- SUNROOF MOTOR ASSEMBLY
- WATER LEVEL SWITCH

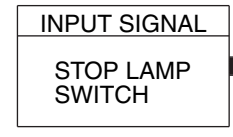
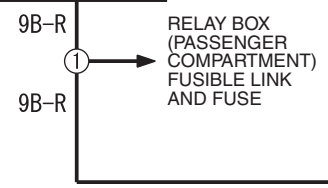
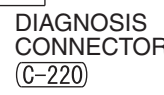
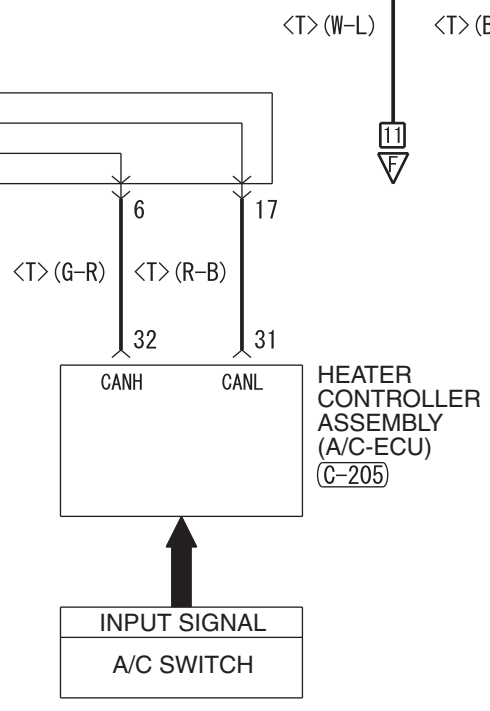
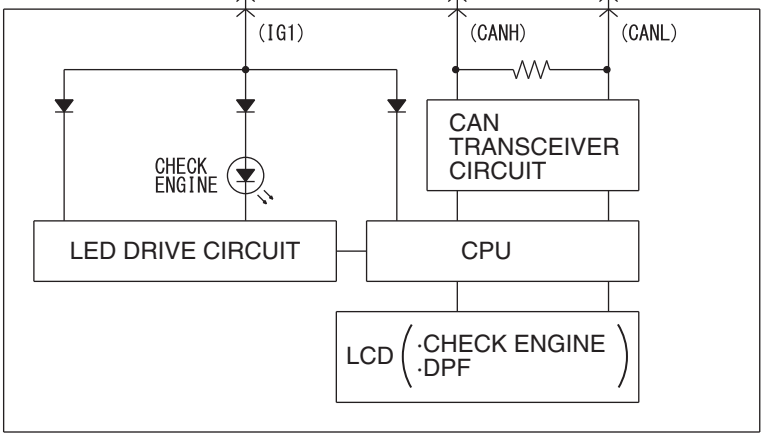
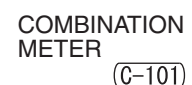

17

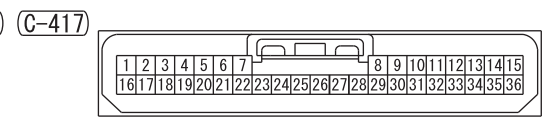
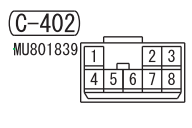
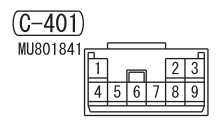
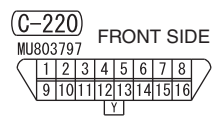
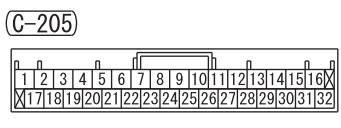
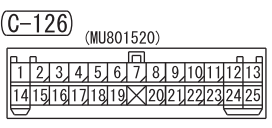
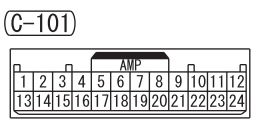
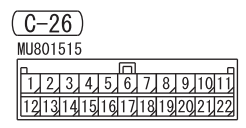

Wire colour code
 B : Black LG : Light green G : Green L : Blue W : White Y : Yellow SB : Sky blue BR : Brown
 O : Orange GR : Grey R : Red P : Pink V : Violet PU : Purple SI : Silver BE : Beige