

N10

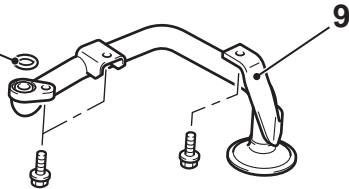

8

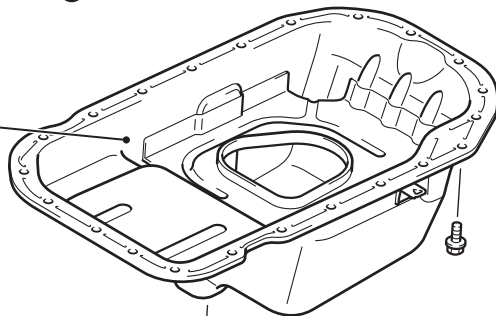

N2

1

39 N·m

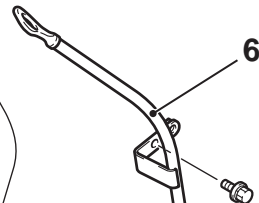

6

5

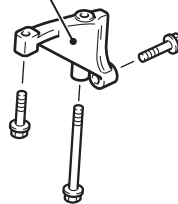

7 N

(Engine oil)

5

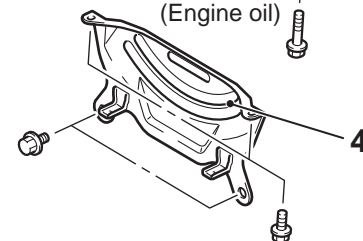
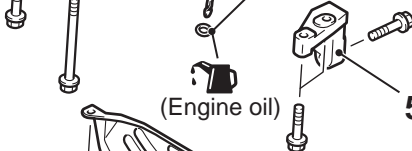

4

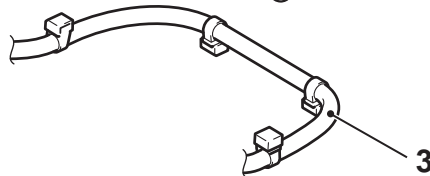

3