

<Side shield cover>

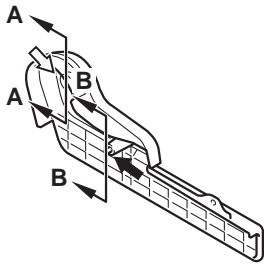

Section A – A

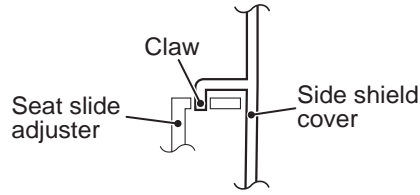

Section B – B

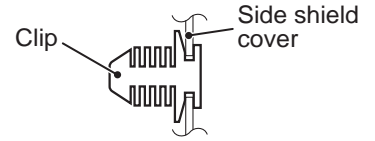

<Front rail cover>

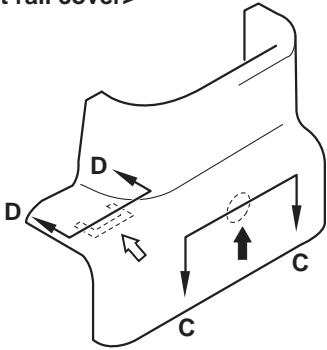

Section C – C

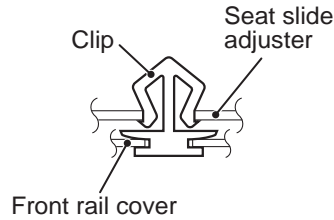

Section D – D

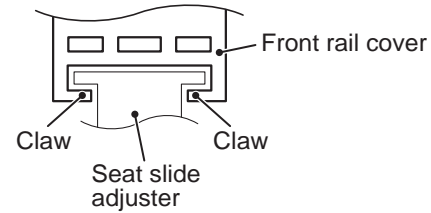

<Hinge cover>

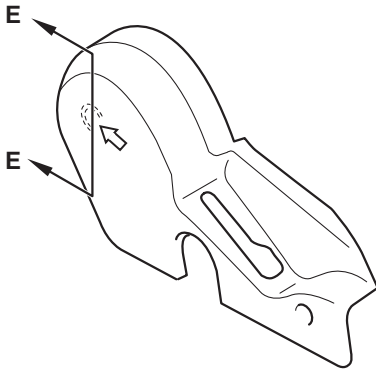

Section E – E

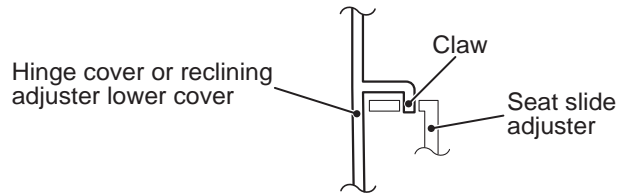

<Reclining adjuster lower cover>

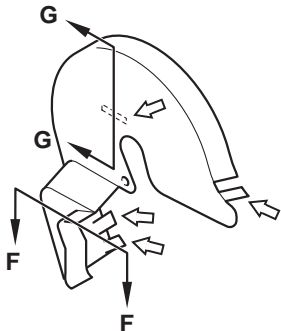

Section F – F

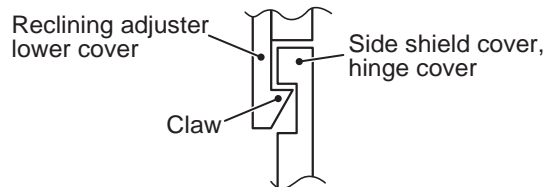

Section G – G

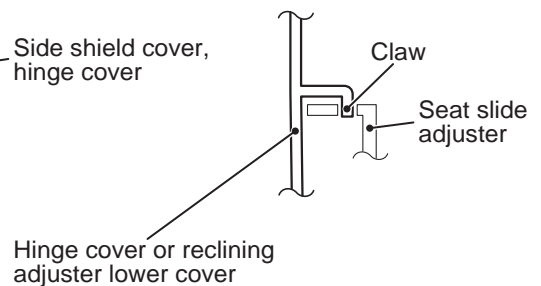

Note

➡ : Clip position

↔ : Claw position