

NOTE
*1 : LHD
*2 : RHD

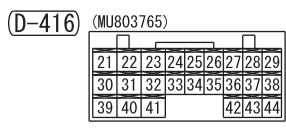
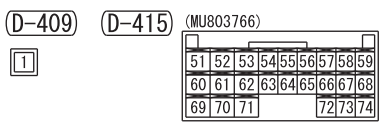
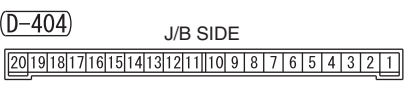
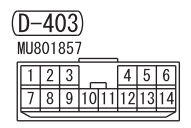
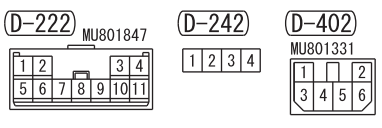
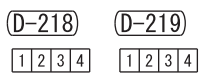
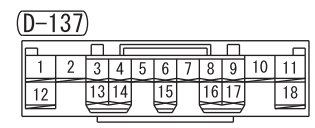
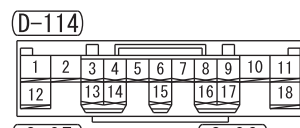
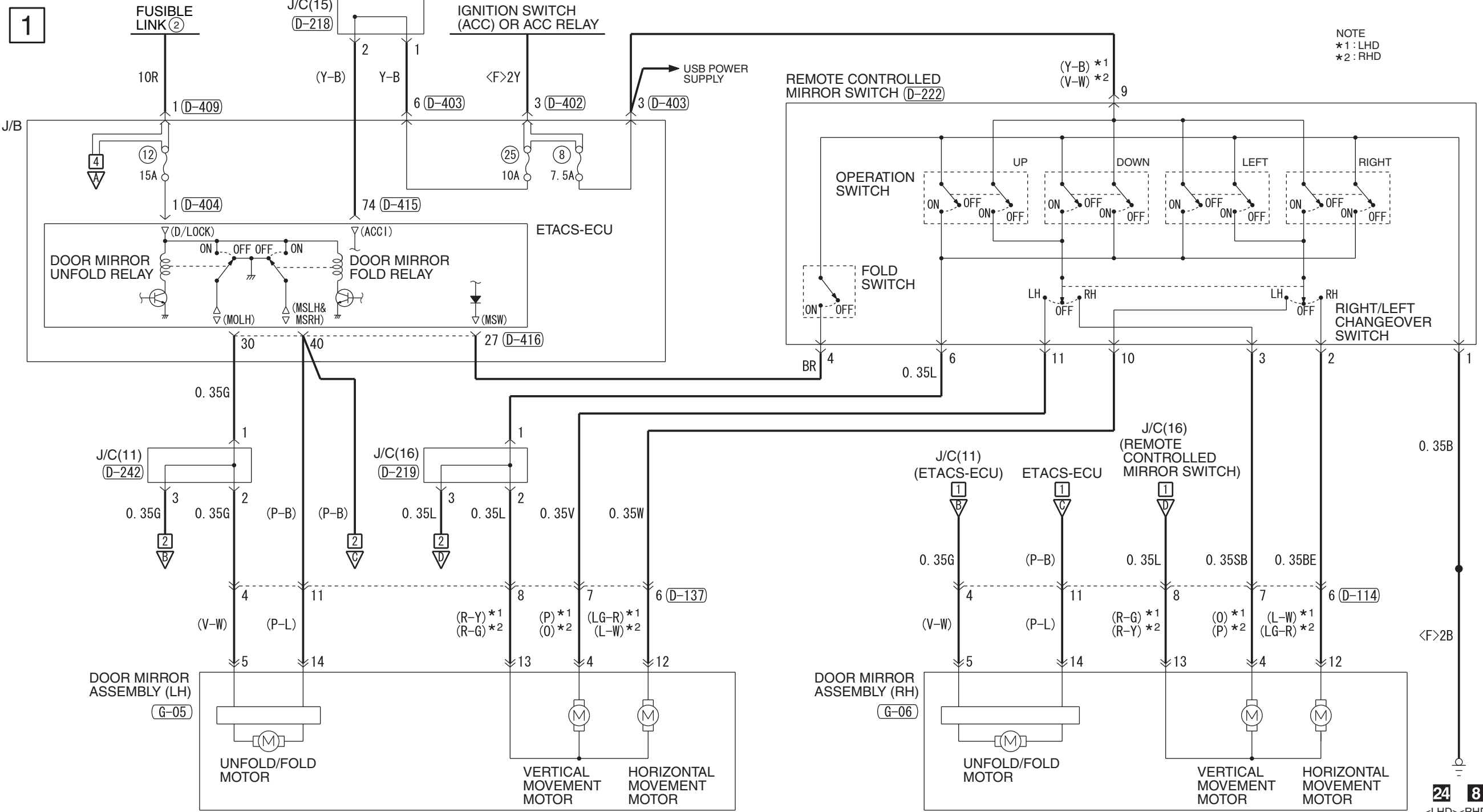

Wire colour code
 B : Black LG : Light green G : Green L : Blue W : White Y : Yellow SB : Sky blue BR : Brown
 O : Orange GR : Grey R : Red P : Pink V : Violet PU : Purple SI : Silver BE : Beige