

IGNITION SWITCH (IG1) OR IG1 RELAY

- 4WD INDICATOR-ECU
- A/C-ECU
- BLIND SPOT WARNING SWITCH CONTROL UNIT
- CLEARANCE WARNING CONTROL UNIT
- COLUMN SWITCH (STEERING WHEEL SENSOR)
- ELECTRIC PARKING BRAKE
- ETACS-ECU
- GATEWAY-ECU
- SELECTOR LEVER ASSEMBLY (SHIFT LOCK SOLENOID, SHIFT SWITCH)
- SONAR SWITCH
- TRANSFER-ECU

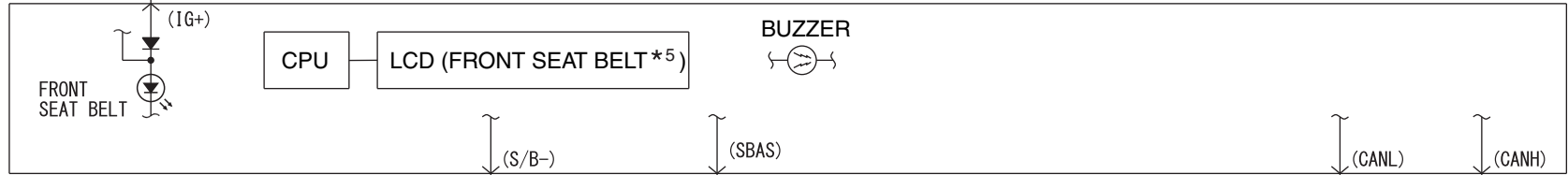

COMBINATION METER (D-215)

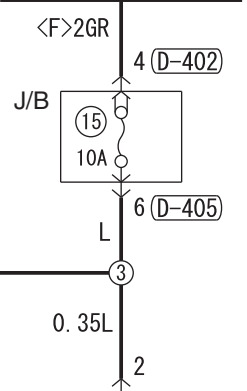
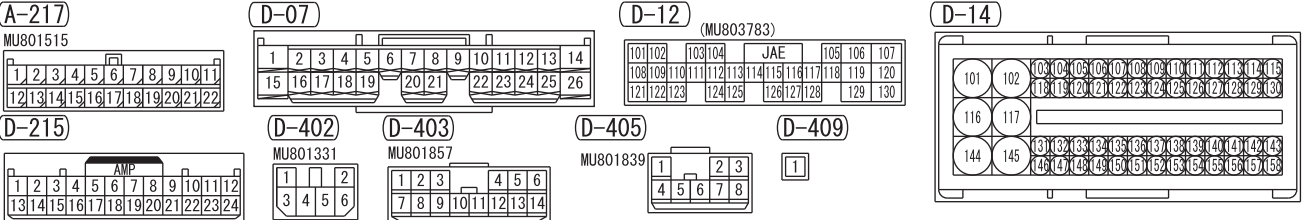
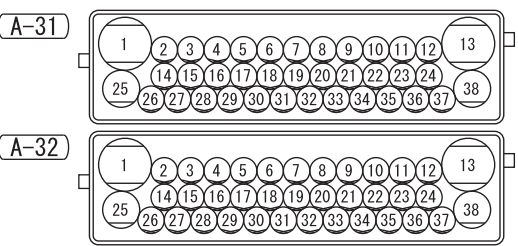
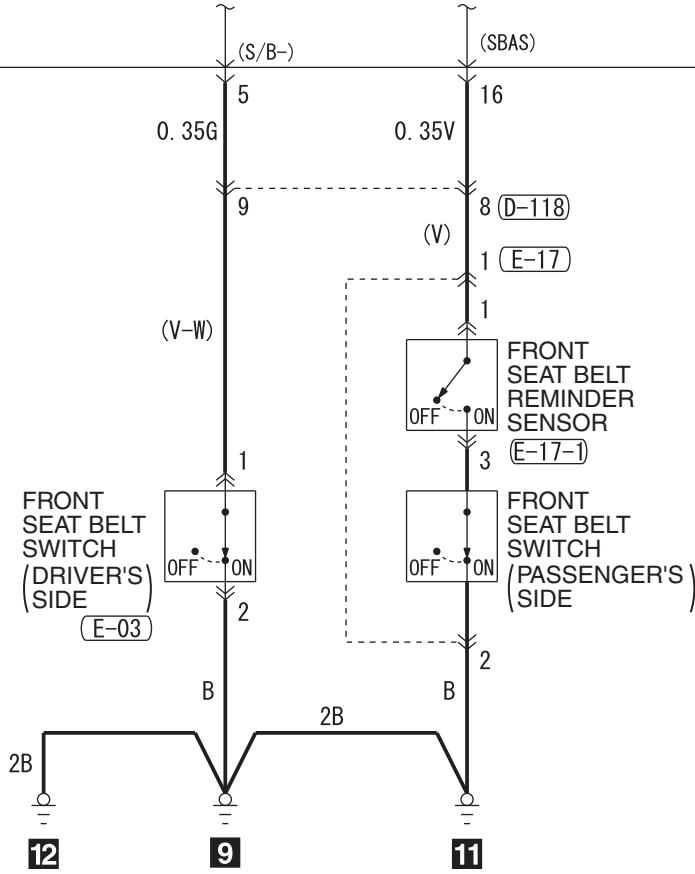

NOTE
 *1: 6B3
 *2: 4D5,4N1
 *3: VEHICLES WITHOUT ASTC
 *4: VEHICLES WITH ASTC
 *5: COLOUR LIQUID CRYSTAL DISPLAY TYPE

ENGINE-ECU (D-12)*1 (D-14)*2

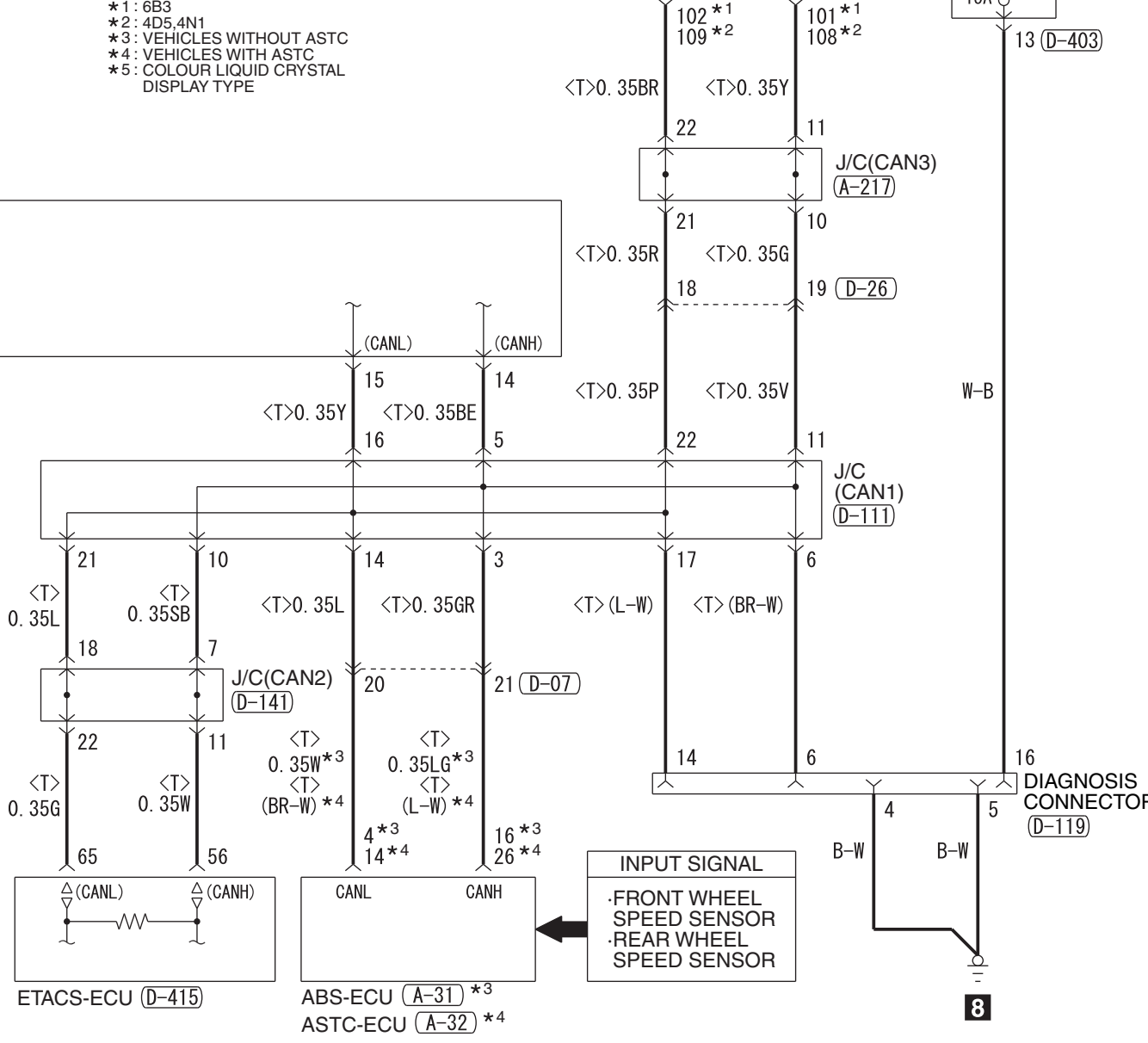
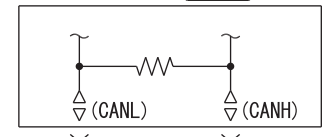

FUSIBLE LINK (2)

