

<Single cab>

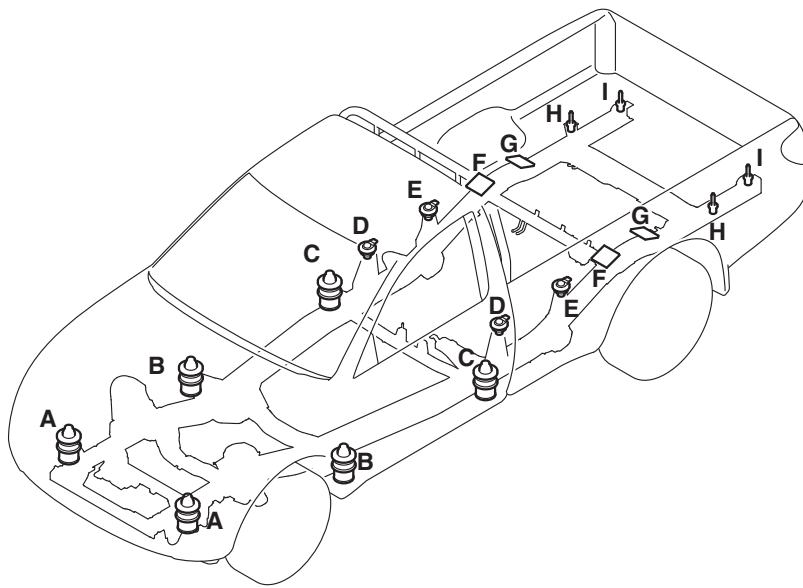

A

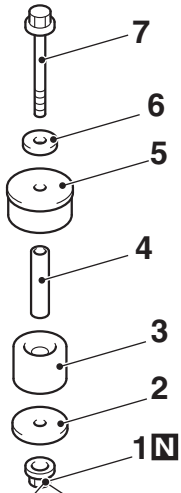

47 ± 7 N·m 56 ± 5 N·m
<2WD> <4WD, H/R>

B

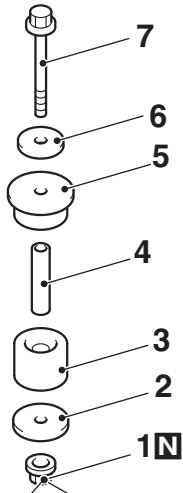

47 ± 7 N·m 56 ± 5 N·m
<2WD> <4WD, H/R>

C

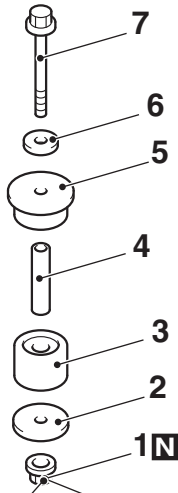

47 ± 7 N·m 56 ± 5 N·m
<2WD> <4WD, H/R>

D

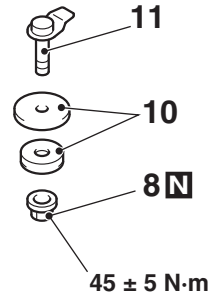

45 ± 5 N·m

E

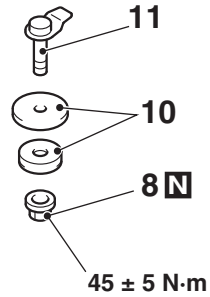

45 ± 5 N·m

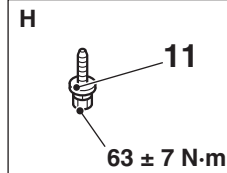
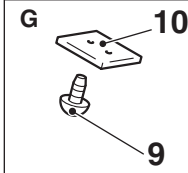
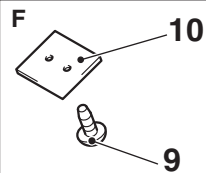

63 ± 7 N·m

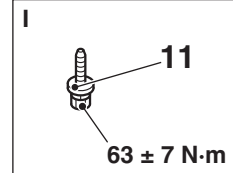

63 ± 7 N·m