

<VEHICLES WITH INTERCOOLER>

ELECTRONIC-CONTROLLED THROTTLE VALVE (B-15)

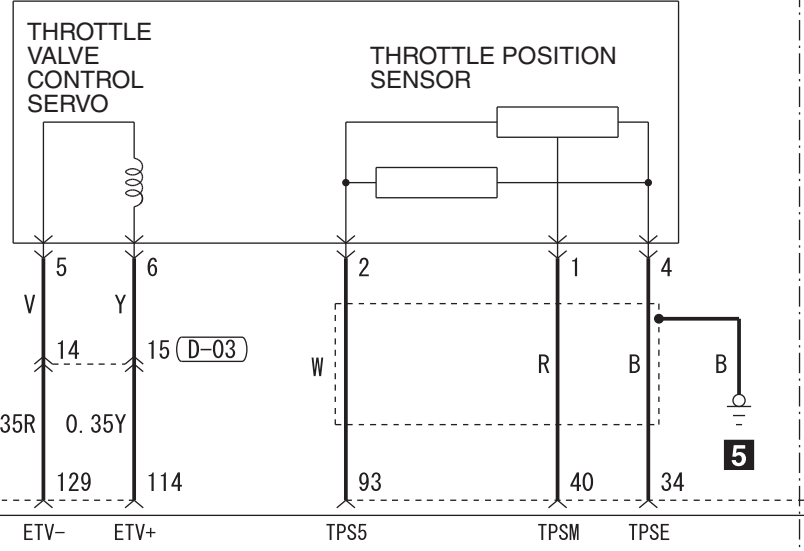

ENGINE-ECU

- BRK 110
- CNTS 139
- SW- 154
- APS5 149
- APSM 150
- APSE 151
- AP5 134
- APSS 135
- APE 136
- 4L 127
- SGND 145
- GNDB 116
- GNDE 117 (D-11)
- FPSS 70
- FPS 64
- FPSE 88

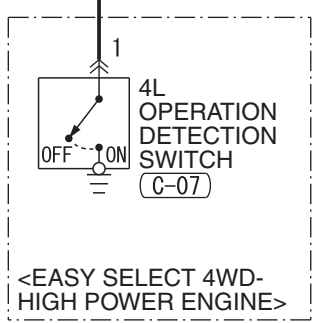
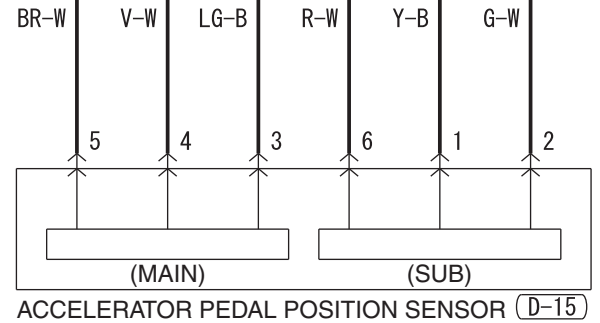
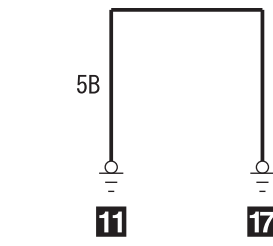
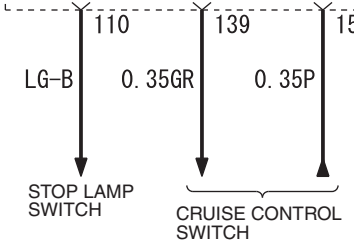

<EASY SELECT 4WD-HIGH POWER ENGINE>

- A-09
- B-09 (MU802607)
- B-11 (MU802408)
- B-15 (MU805200)
- C-07 (MU802653)
- D-03
- D-11
- D-15 (MU805200)

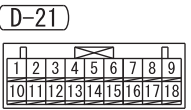

MANIFOLD ABSOLUTE PRESSURE SENSOR (A-09)

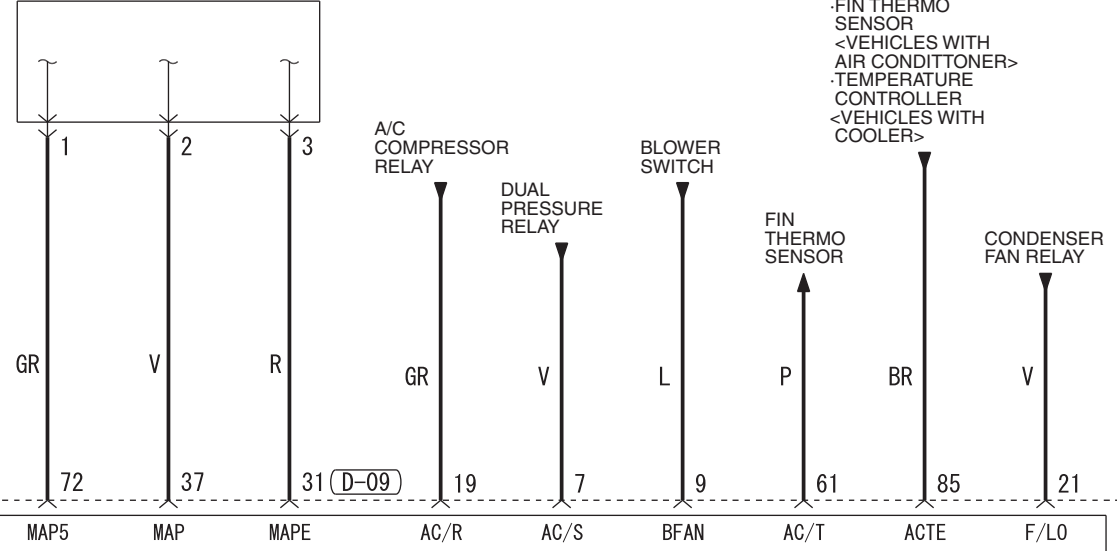

- MAP5 72
- MAP 37
- MAPE 31 (D-09)
- AC/R 19
- AC/S 7
- BFAN 9
- AC/T 61
- ACTE 85
- F/LO 21

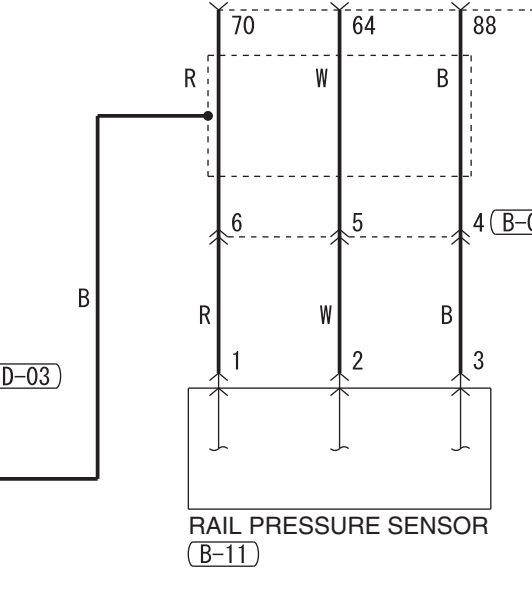
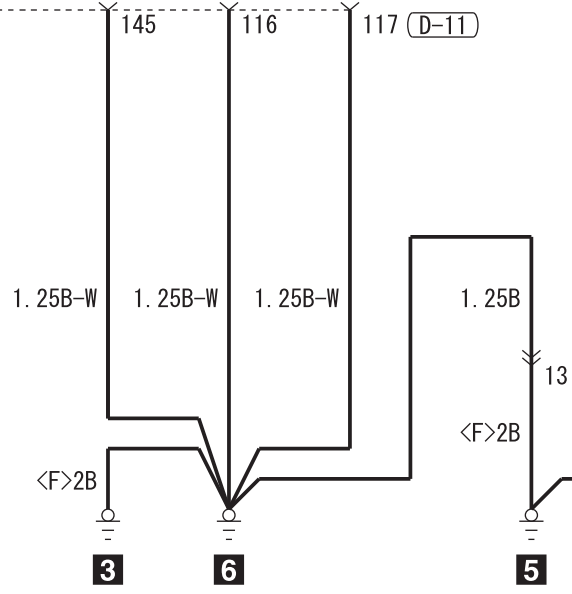

- D-09
- D-11
- D-15 (MU805200)

